

# **ALEKO 12W x 26L x 10H ft. Metal Carport**

Installation & Owner's Manual

# Table of contents

Pre-Assembly Instructions	.....	<b>01</b>
Building the Foundation	.....	<b>02</b>
Floor Plan	.....	<b>03</b>
Parts for Assembly	.....	<b>04</b>
Carport Frame Diagram	.....	<b>05</b>
Assembling Process	.....	<b>05</b>
Care & Maintenance	.....	<b>11</b>



## **12W x 26L x 10H ft. Metal Carport**

**Assembled Dimensions: Approx. 12W x 26L x 10H ft.  
Storage Area: 315.2 sq. ft.**

**CAUTION:** Some parts have sharp edges. Please read safety information provided in this manual before beginning assembly. Wear protective gloves when handling metal parts.

### **Pre-Assembly Instructions**

1. Check local building code requirements regarding foots and location.
2. Watch the weather and choose a day for assembly that is not windy or wet.
3. At least two people are required to assembly your carport.
4. Decide which method of anchoring and the type of foundation you wish to use. The basic tools and materials required for assembly will depend on which option you select.
5. Choose a ground that slopes slightly away from the carport to keep water away.



## **Building the Foundation**

If you are building a foundation, the concrete slab should be at least 3-4 inches thick. It must be level and flat to provide good support for the frame.

The following materials are recommended for building a concrete foundation:

- Concrete (a mix of 1 part cement, 3 parts pea-sized gravel, 2-1/2 parts clean sand)
- Sheet of 6 mil plastic
- 1x4-in. concrete form (will be removed once the concrete cures)





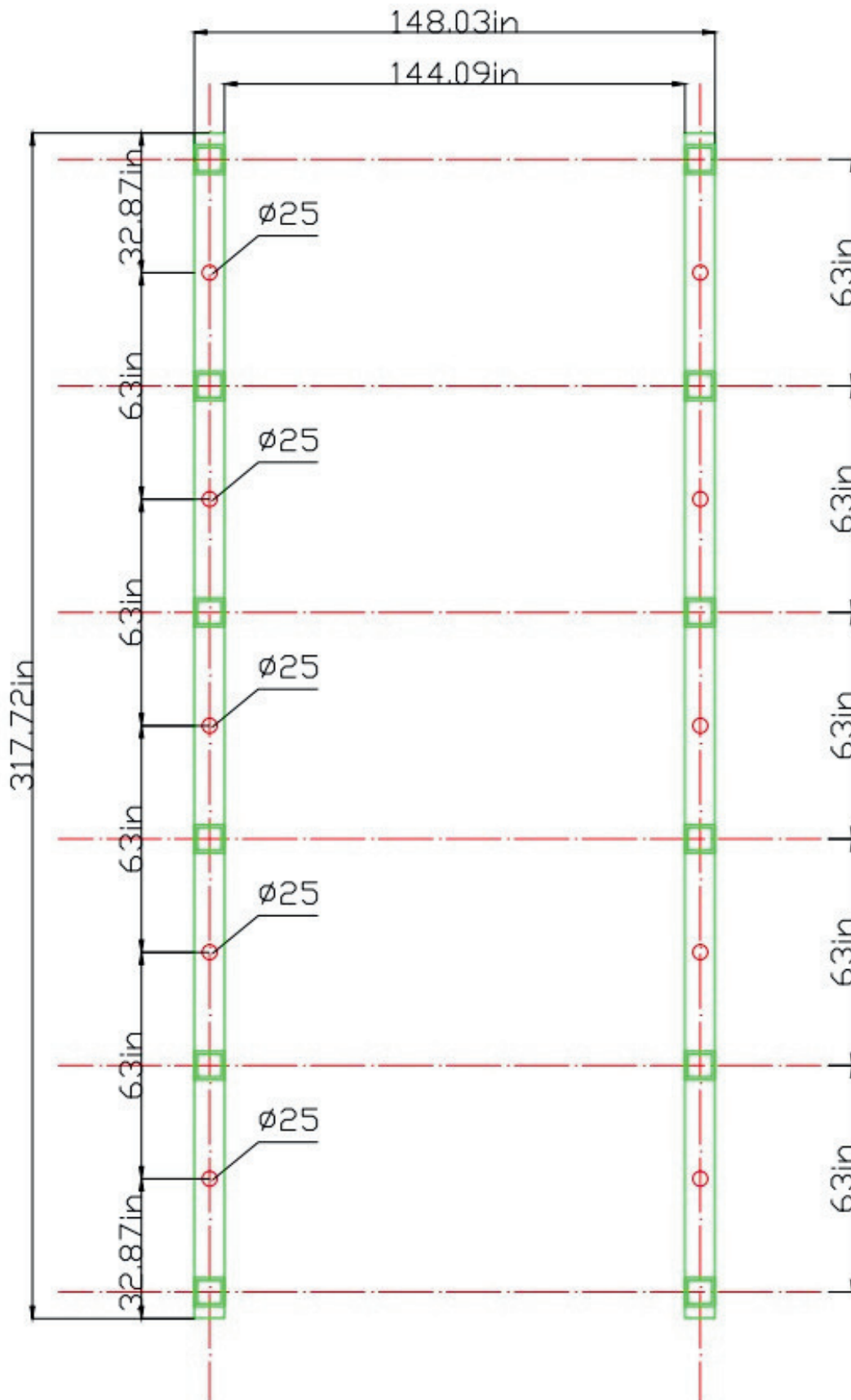









Floor Plan



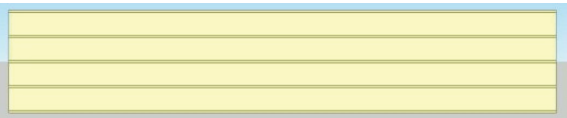

**Parts for Assembly**

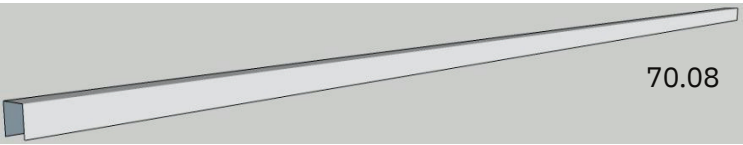
Part No.	Diagram	Length(in)	QTY(pcs)
A1		8.27	4
A2		59.45	10
A3		13.78	8
B1/D		62.6	12/12
B2		32.87	12
C		25.2	12
E		20.47	6
F1		41.54	4
F3		68.11	6
F2		63	2
P		70.08	55
X			6
U		72.83	10
U1		72.83	5
U2			5



S0 10



S1 600



S2 12



H 8



O 12



G 3



### Carport Frame Diagram

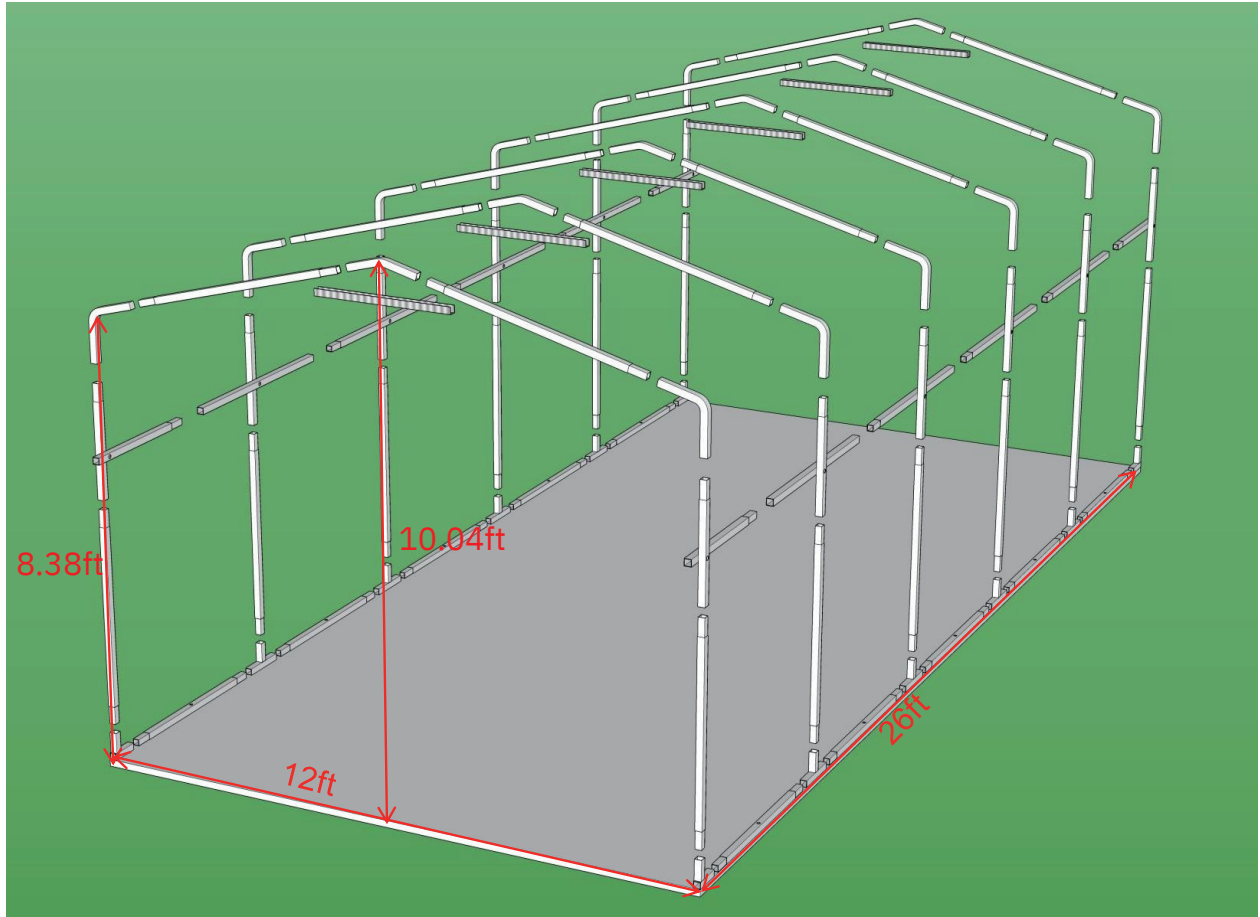

### Step 1: Assemble the Carport Base

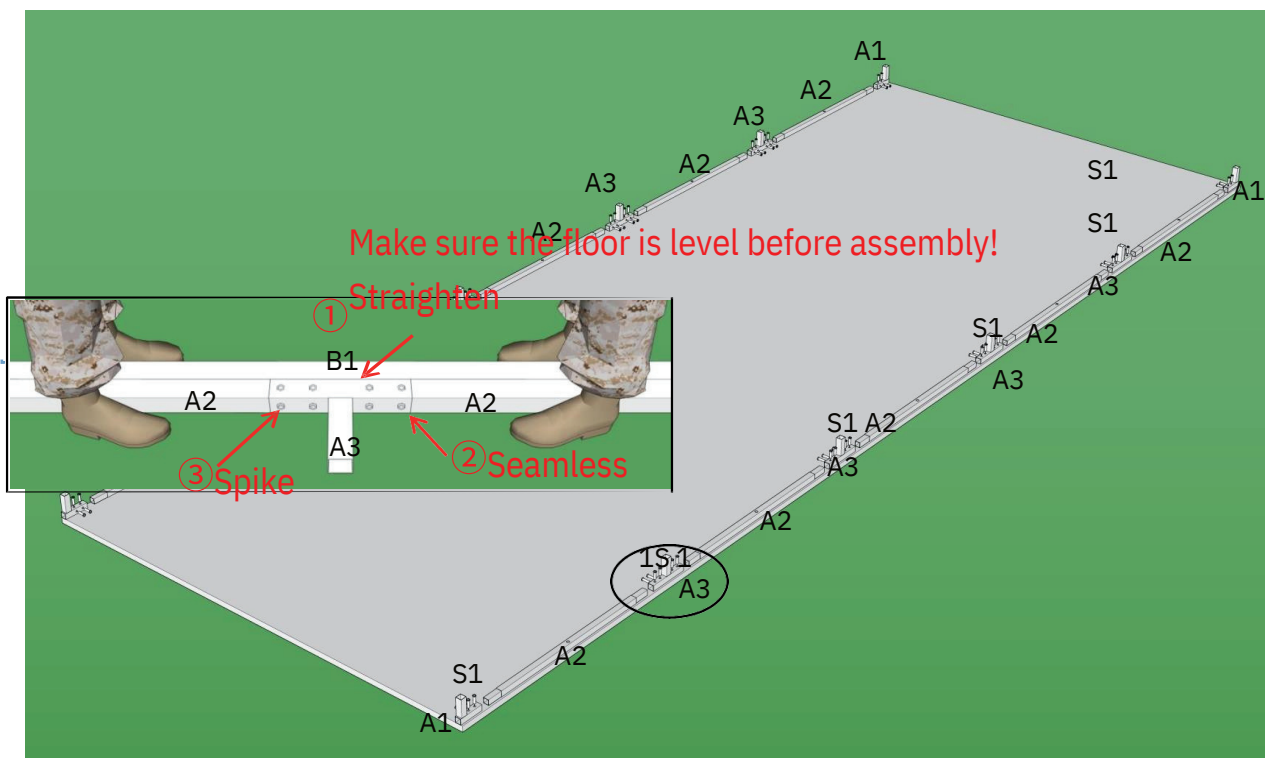



### Step 2: Assemble Carport Frame

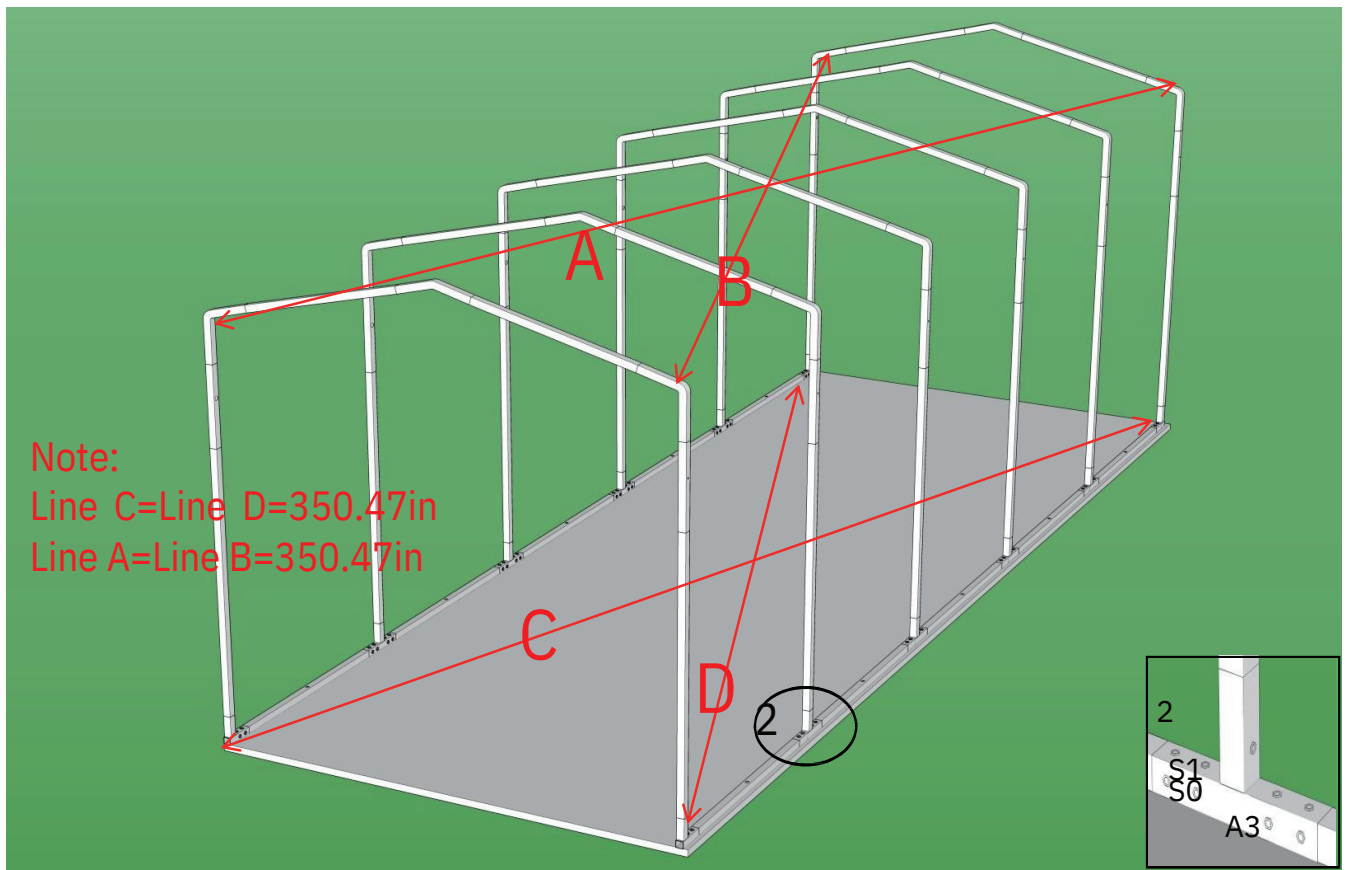
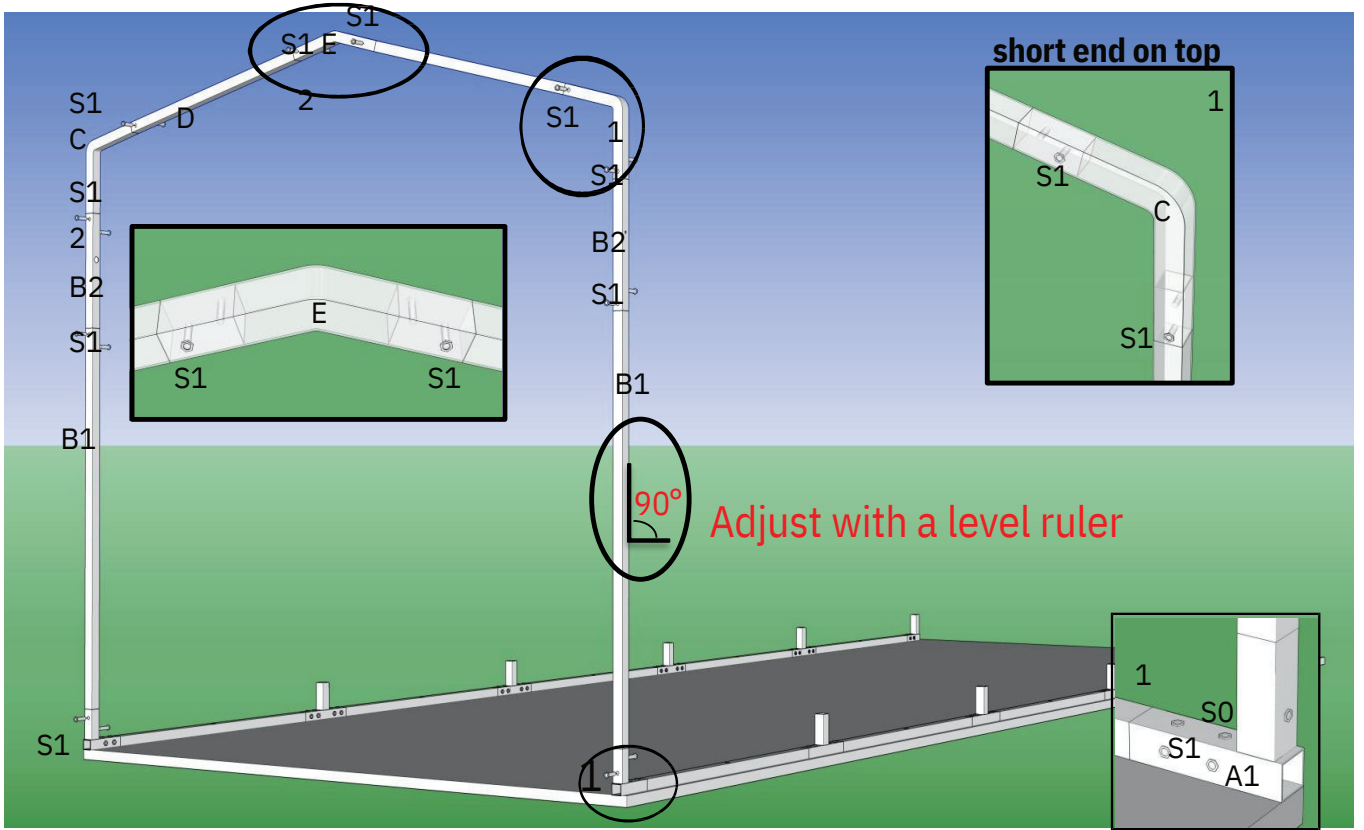



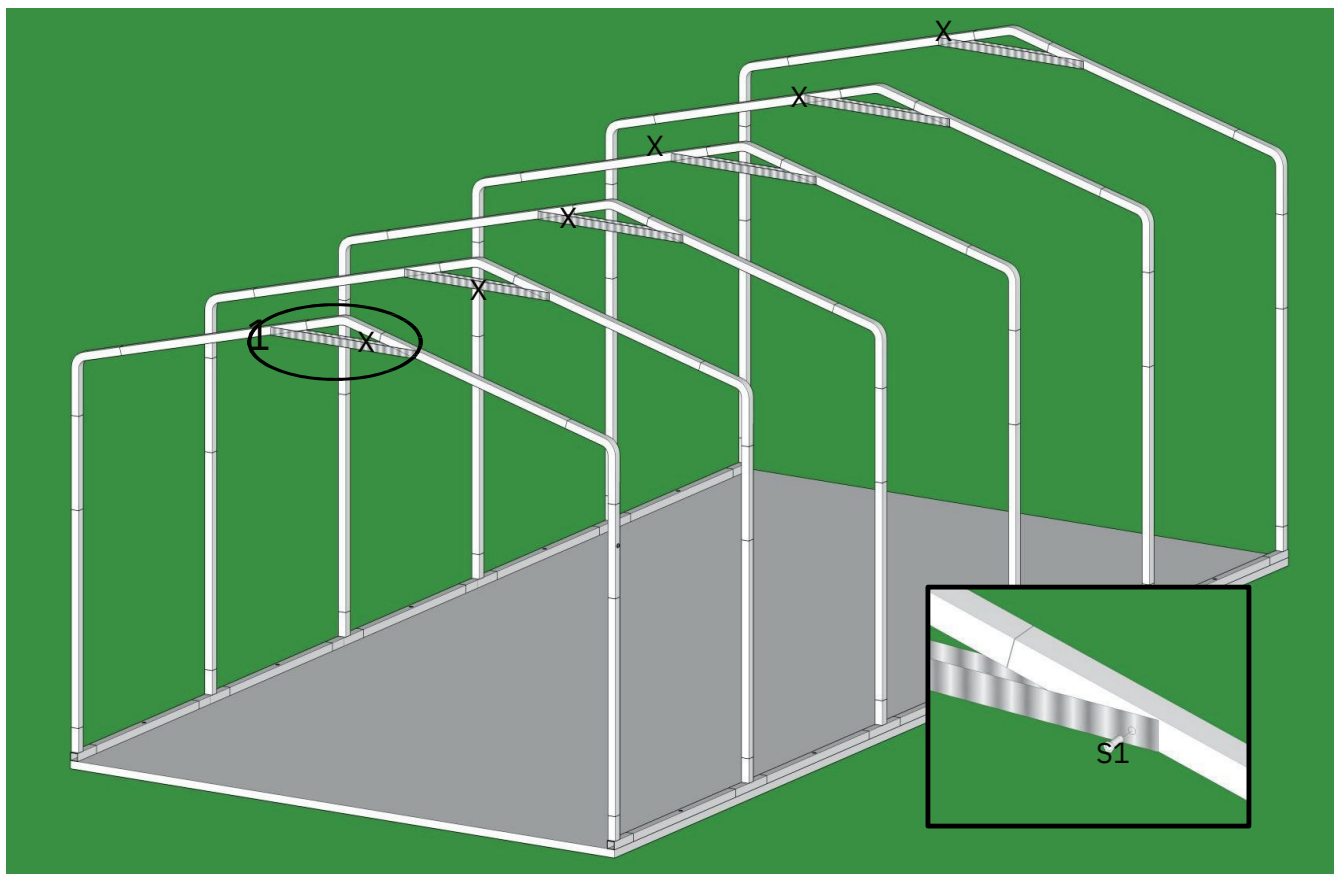
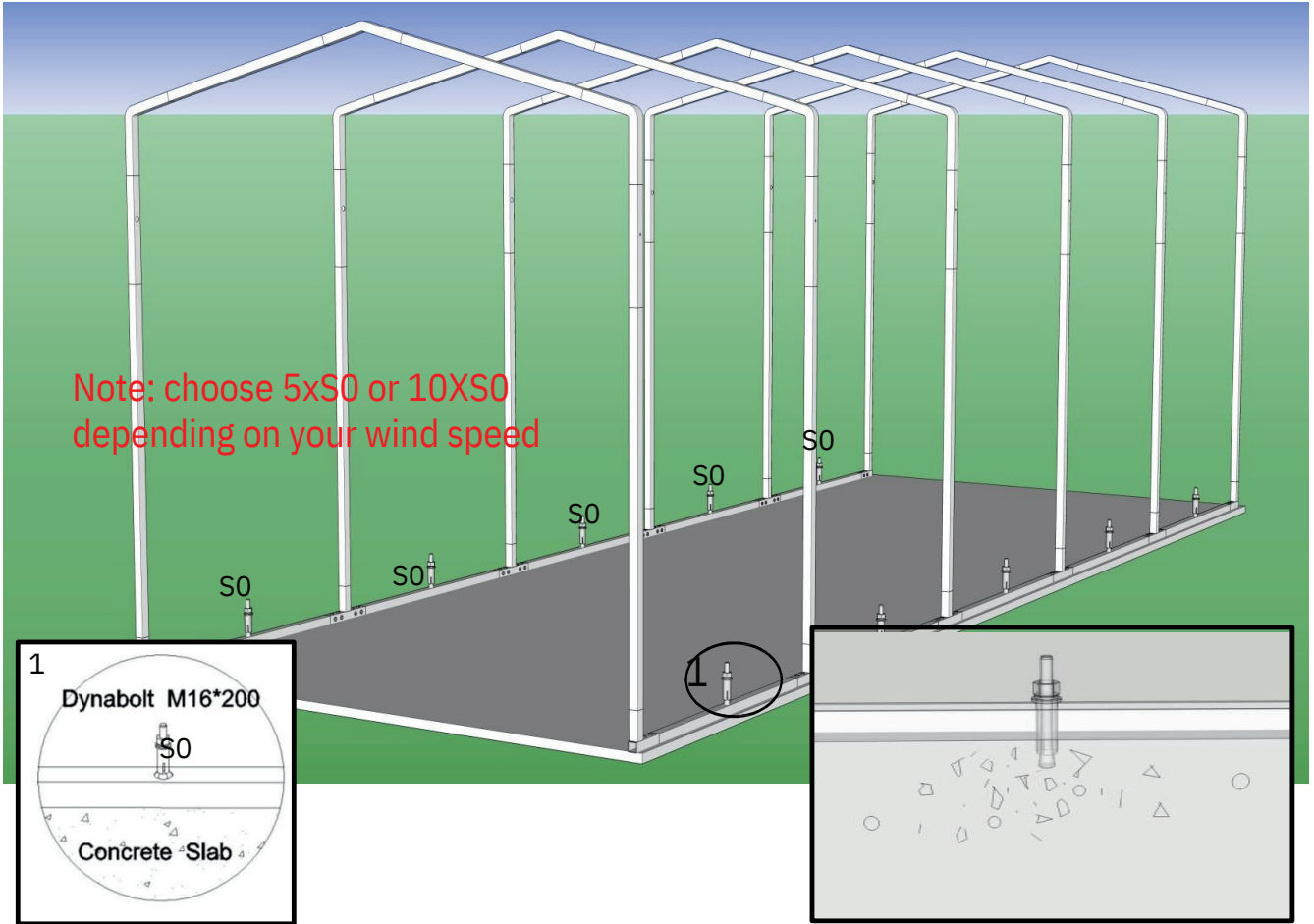



### Step 3: Assemble Stiffener Bars

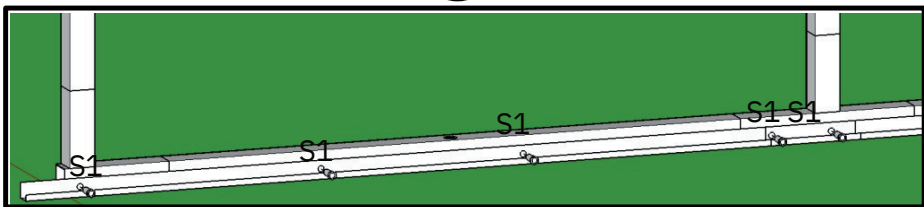
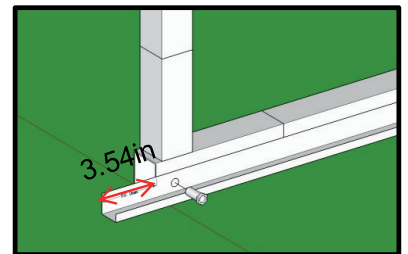
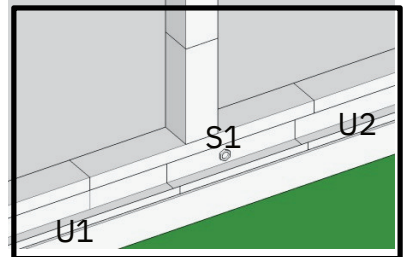
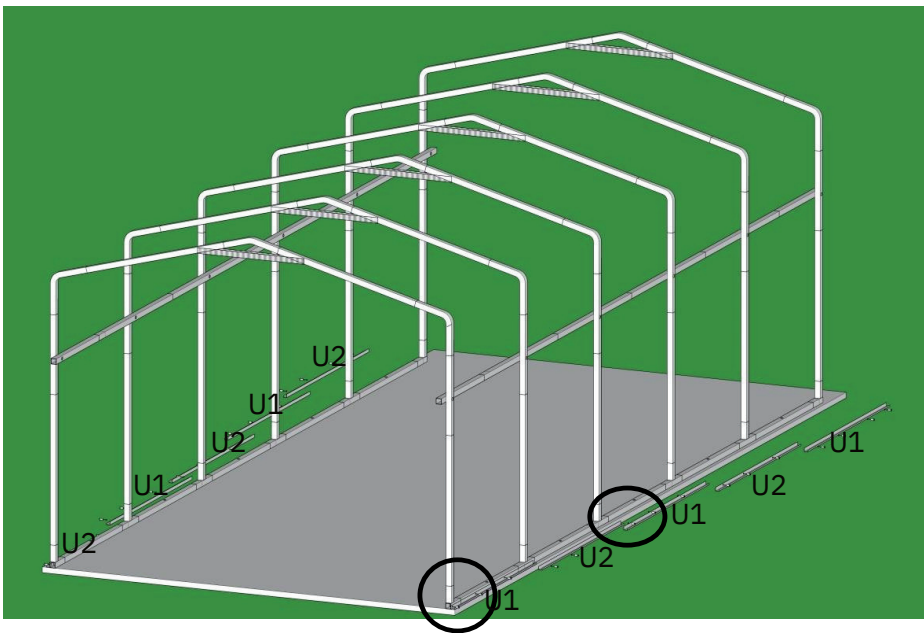
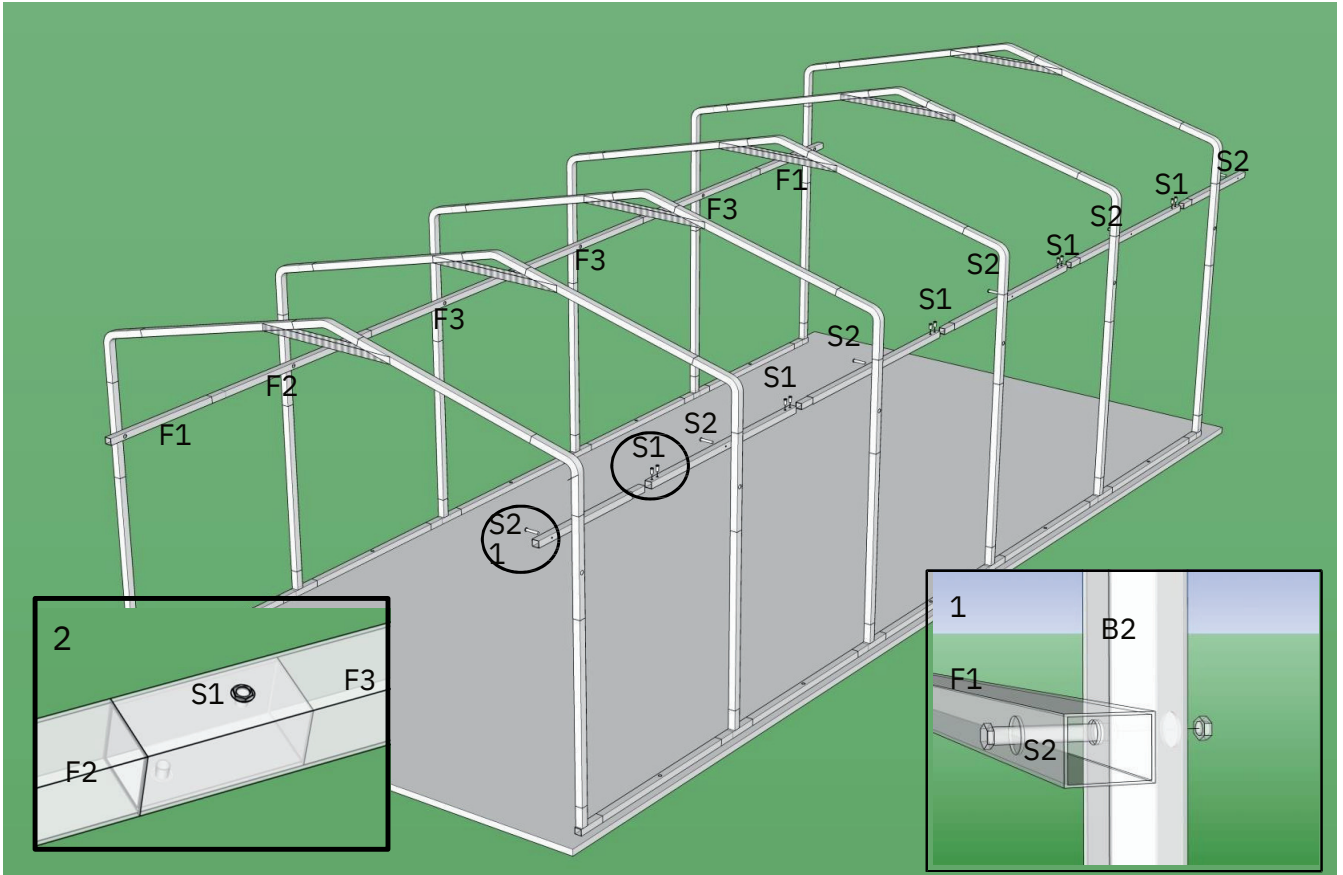



### Step 4: Assemble Roof Panels

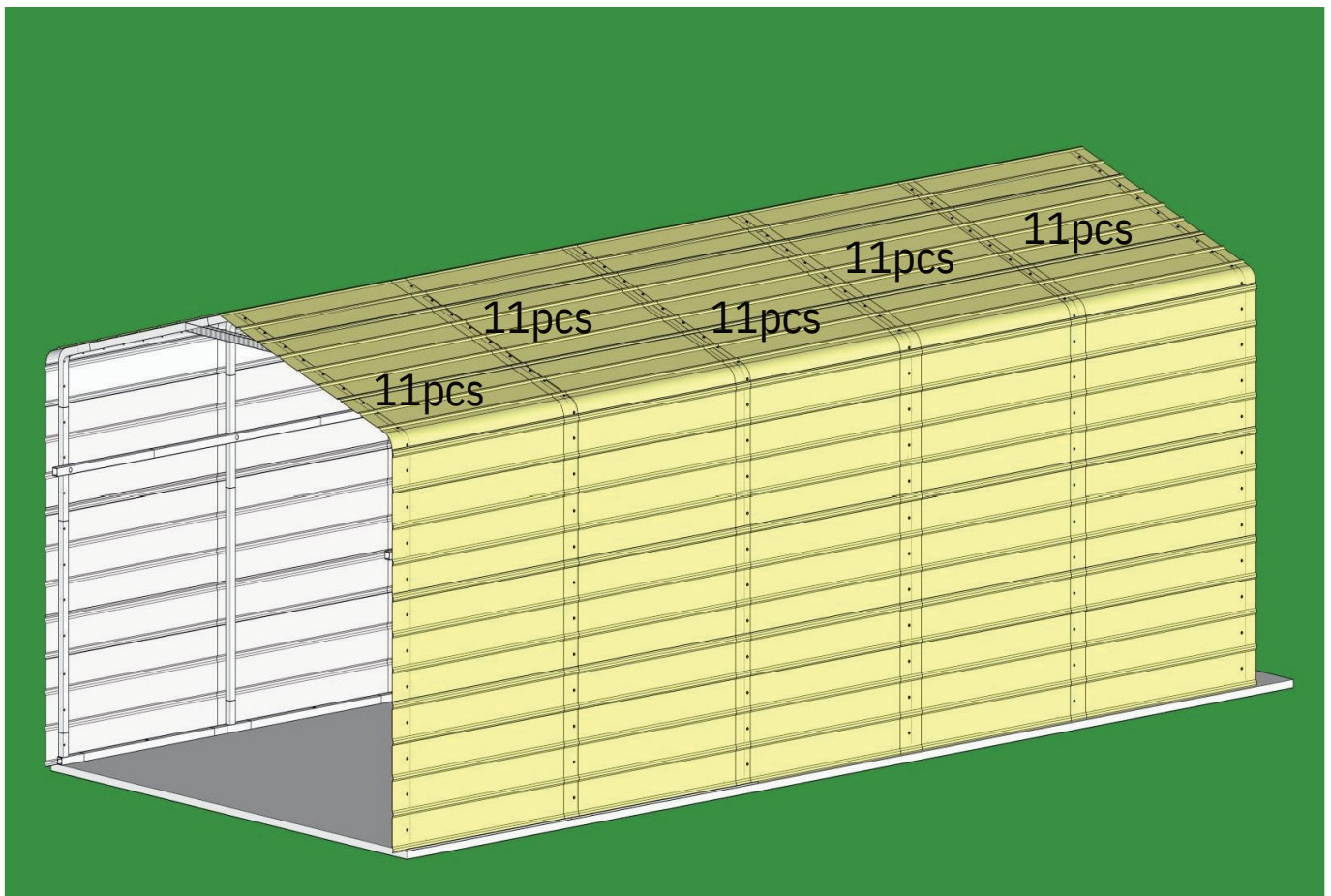
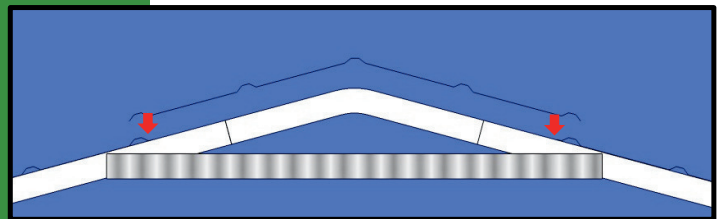
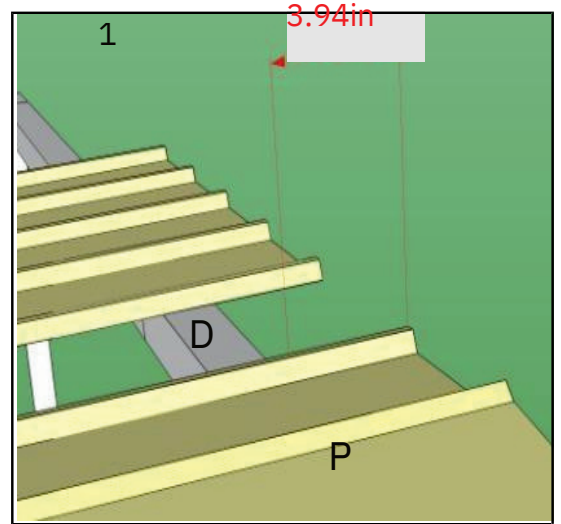
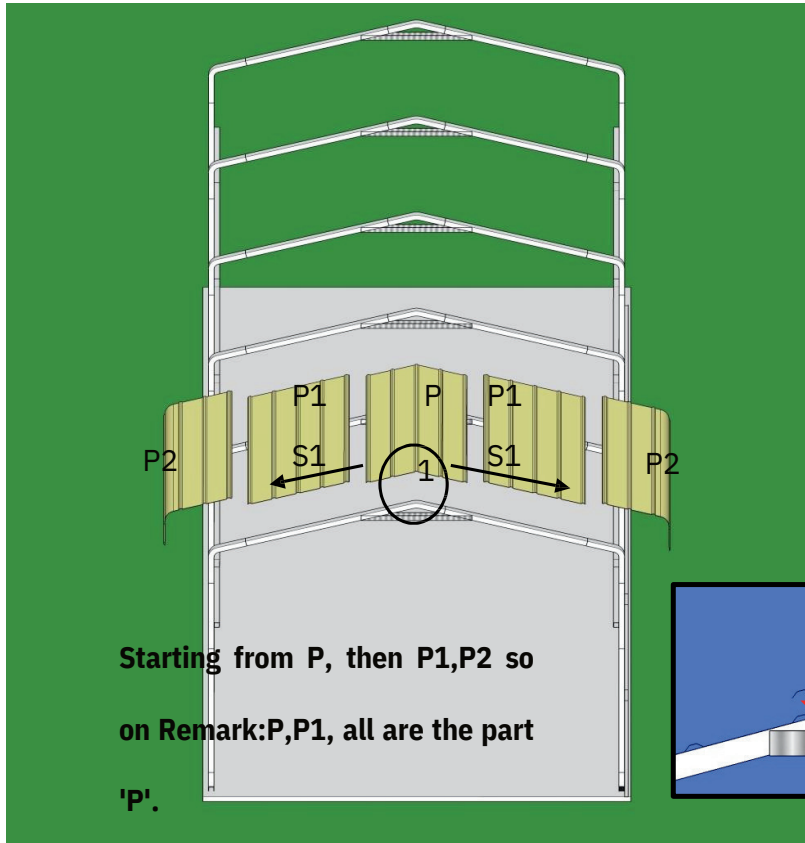



**Step 5: Assemble the Trim**

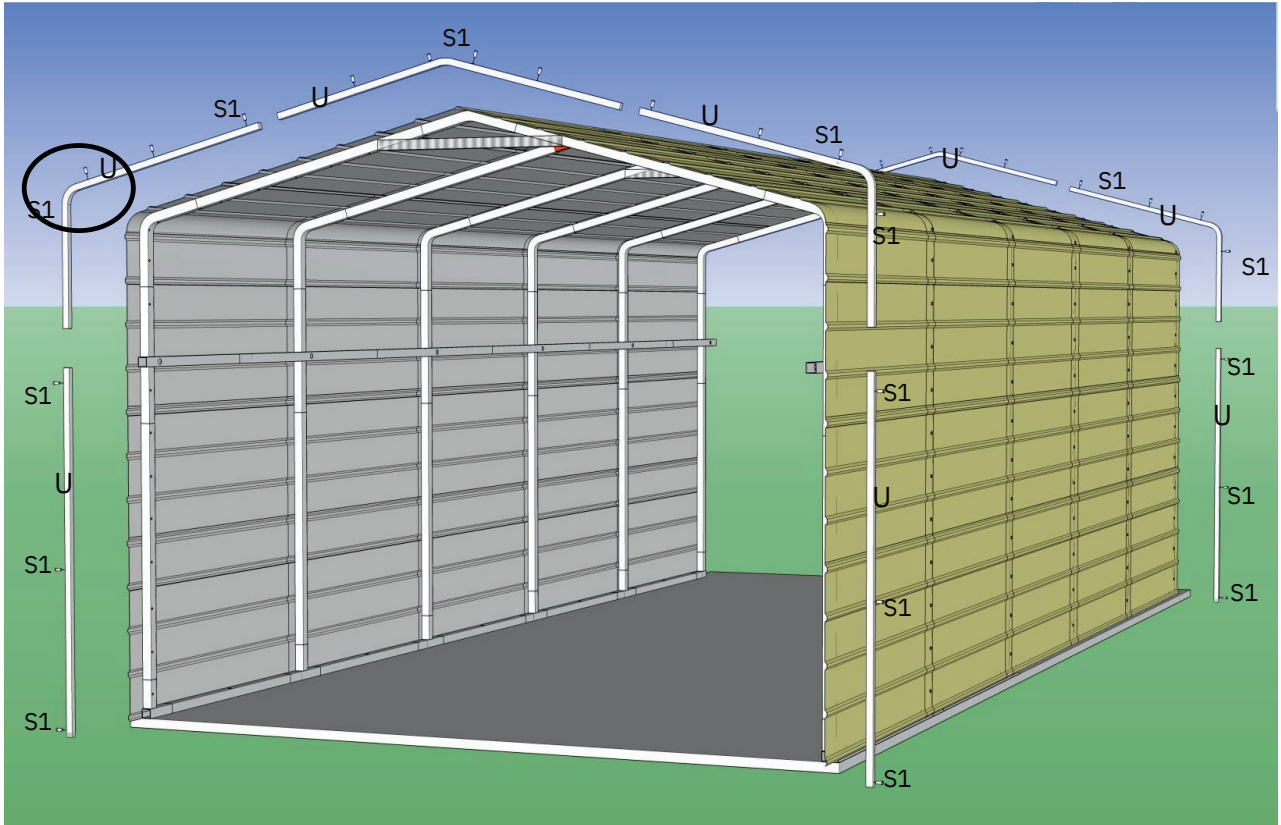



## **Care & Maintenance**

### **Perform Routine Checks**

Inspect your carport at least twice a year for any damage caused by harsh weather. Following severe weather, immediately inspect carport for dents, small holes, missing screws and bolts, or any other damage that could compromise steel panels and frame.

### **Keep Your Building Clean**

Prevent fungi or other materials from building up on your carport by cleaning at least once a year (or more as needed). Use either an ammonia mix or a gentle household cleaning product with warm water to remove the grime, grease, and mud. For stubborn mildew, clean separately with bleach.

### **Tackle Minor Repairs Immediately**

Small holes or scratches can grow quickly when exposed to the elements. By promptly tackling minor repairs, such as priming and painting scratched paint, you can stop further damage in its tracks.

### **Clean and Wax Exterior Surface**

To help maintain a long-lasting finish, periodically clean and wax the exterior surface.

### **Keep Roof Clear**

Keep roof clear of heavy snowfall to prevent damage that can make your carport unsafe to enter. If in snow country, invest a Roof Strengthening Kit for added protection against snow accumulation.



### **Lubricate Door Tracks**

Keep door tracks clear of dirt and other debris that prevent them from sliding easily. Lubricate the door track annually with furniture polish or silicone spray, and keep doors closed and locked to prevent wind damage.